

WPA252010S-1R5ML

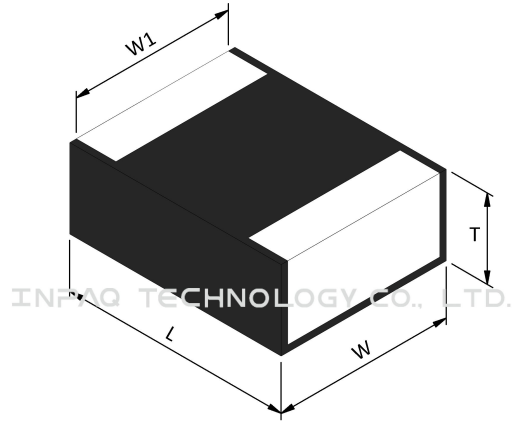

外观&形状

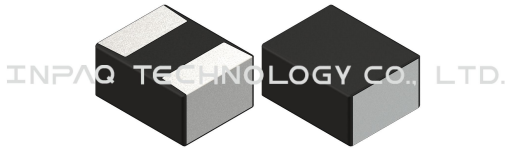

Series	L [mm]	W [mm]	W1 [mm]	T [mm]
201610	2.0±0.2	1.6±0.2	1.4±0.2	1.0 max.
201612	2.0±0.2	1.6±0.2	1.4±0.2	1.2 max.
252010	2.5±0.2	2.0±0.2	1.8±0.2	1.0 max.
252012	2.5±0.2	2.0±0.2	1.8±0.2	1.2 max.



注意 NOTICE: All Specifications are subject to change without notice.

Page 1/5

1. 本文件由 INPAQ 佳邦科技網站下載，若規格變更及停產，請於訂購時確認，恕不另行通知。
2. 本文件僅說明參考標準規格，如需訂購，請依實際核准所需規格進行申辦。

规格

長(公釐)	2.5±0.2
寬(公釐)	2.0±0.2
高(公釐)	1.0 max.
尺寸代碼英吋(公釐)	1008/2520
感值(uH)	1.5
典型值直流阻抗(mΩ)	62
最大值直流阻抗(mΩ)	72
典型值飽和電流(A)	3.8
最大飽和電流(A)	3.4
典型值溫升電流(A)	2.9
最大溫升電流(A)	2.5
品質因素	30
自我諧振頻率[MHz]	60
耐壓(DC)	20V DC
操作溫度°C	-40°C to +150°C

注意 NOTICE: All Specifications are subject to change without notice.

Page 2/5

1. 本文件由 INPAQ 佳邦科技網站下載，若規格變更及停產，請於訂購時確認，恕不另行通知。
2. 本文件僅說明參考標準規格，如需訂購，請依實際核准所需規格進行申辦。

特点

Notes

1. Customized design is available, please contact us.
 2. All test referenced to 25°C ambient.
 3. Inductance tolerance +/- 20%.
 4. Inductance is measured with Agilent® LCR meter 4285A (or equivalent) at 1MHz/1V.
 5. DC resistance is measured with HIOKI® micro-ohm meter RM3542 or equivalent.
 6. Isat : DC current (A) that will cause Li to drop approximately 30%.
 7. Irms : DC current (A) that will cause an approximate ΔT of 40°C.
 8. The rated current value is following either Isat (max.) or Irms (max), which value is lower one.
 9. The part temperature (ambient + temp rise) should not exceed 125°C under worst case operating conditions.
- PCB land pattern, trace size - thick, circuit design and proximity to other components are all the factors will affect the temperature performance of the device. Therefore, it should be approved in application conditions and end product.
10. Rated voltage:20V DC (max.)

包装讯息

包裝尺寸(Inch)	標準包裝(KPCS)	單重(gram)	濕敏等級
7	3	0.0277	1

注意 NOTICE: All Specifications are subject to change without notice.

Page 3/5

1. 本文件由 INPAQ 佳邦科技網站下載，若規格變更及停產，請於訂購時確認，恕不另行通知。
2. 本文件僅說明參考標準規格，如需訂購，請依實際核准所需規格進行申辦。

特性曲线

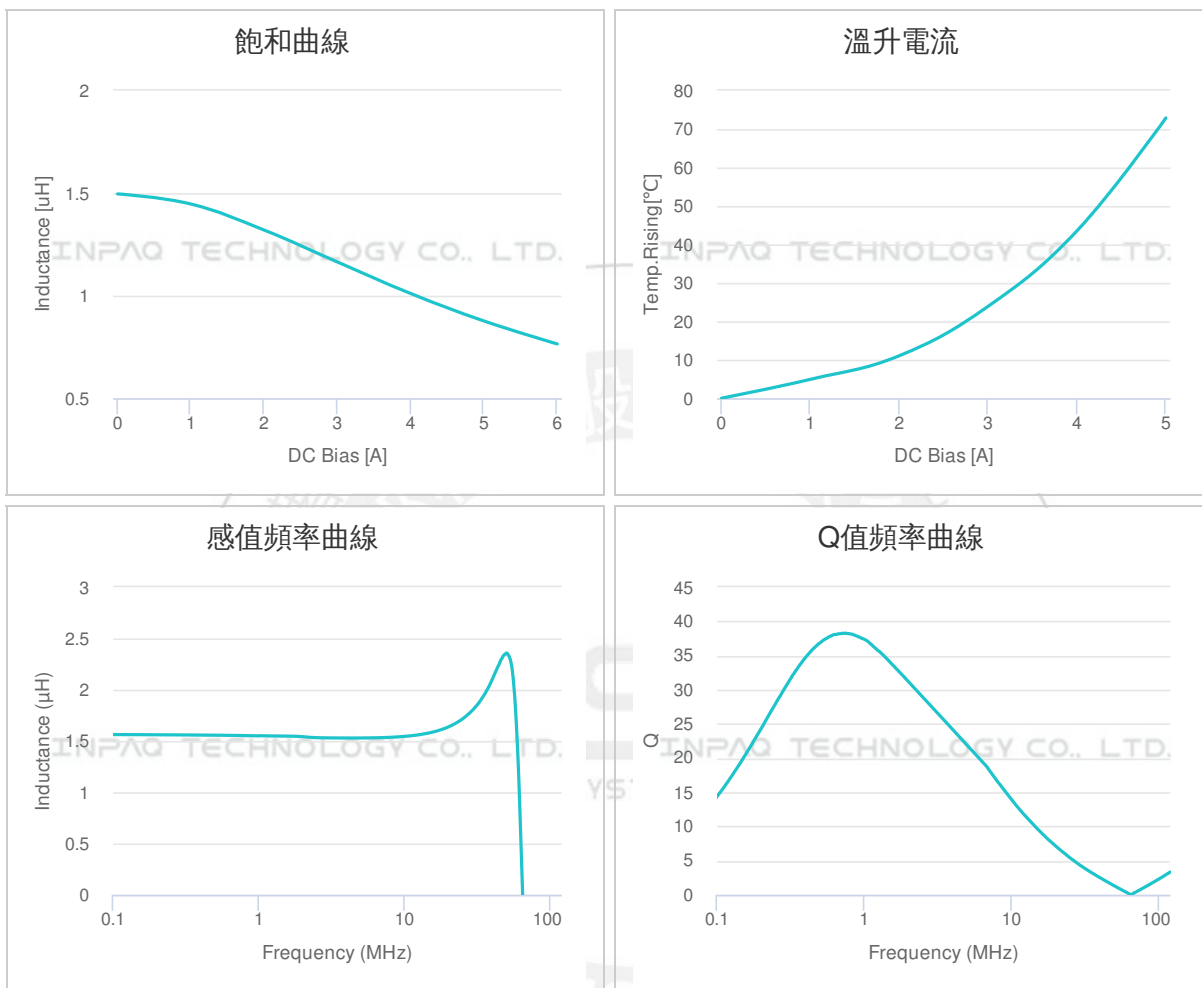

注意 NOTICE: All Specifications are subject to change without notice.

Page 4/5

1. 本文件由 INPAQ 佳邦科技網站下載，若規格變更及停產，請於訂購時確認，恕不另行通知。
2. 本文件僅說明參考標準規格，如需訂購，請依實際核准所需規格進行申辦。

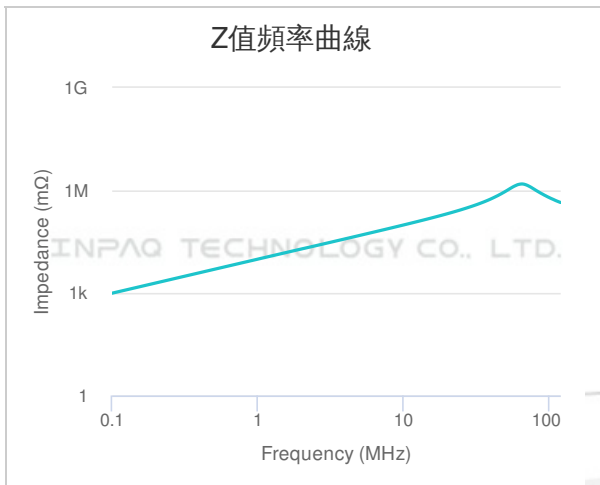

注意 NOTICE: All Specifications are subject to change without notice.

Page 5/5

1. 本文件由 INPAQ 佳邦科技網站下載，若規格變更及停產，請於訂購時確認，恕不另行通知。
2. 本文件僅說明參考標準規格，如需訂購，請依實際核准所需規格進行申辦。