



TCF 02502 DH 900 02 B

Specification

Product Name	Thin Film Common Mode Filter
Series	TCF Series
Part No	TCF 02502 DH 900 02 B
Size	EIA 02502

RoHS **REACH** **TCF 02502 DH 900 02 B Engineering Specification**

1.Scope

TCF 02502 DH Series is a thin film common mode filter designed to suppress common mode noise for high speed differential data lines, such as USB 2.0

These differential interfaces can be used in personal computers, note books, mobile phone, LCD/PDP/DLP TVs, Blu-ray/DVD players, personal handheld equipments, etc.

2. Explanation of Part Number

TCF **02502** **DH** **900** **02** **B** □□
 (1) (2) (3) (4) (5) (6) (7)

1. Product Type : TCF= Thin Film Common Mode Filter
2. EIA Dimension Code
3. Speed Identification Code: : DH= High Speed
4. Impedance(at 100MHz): 900= 90
5. Line Code: 02= 2 lines
6. Specialized Specification Code
7. Control code

3. Circuit Diagram & Dimension

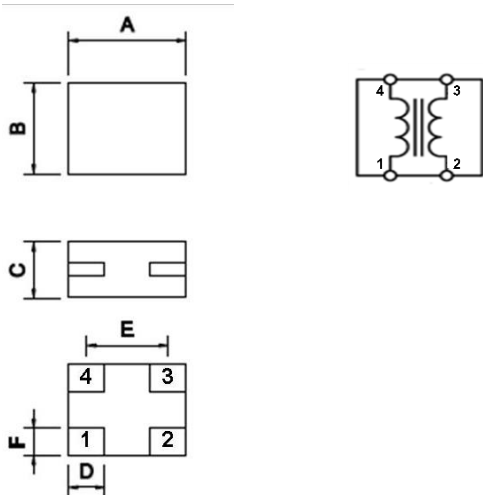

Dimensions in mm

Series	A	B	C	D	E	F
TCF 02502	0.67±0.05	0.52±0.05	0.32±0.05	0.2±0.05	0.45±0.05	0.15±0.1

4. Specifications

4.1. ABSOLUTE MAXIMUM RATINGS

PARAMETER	PARAMETER	RATING	UNITS
Rated Voltage	V_{DC}	5	V
Rated Current	I_{DC}	100	mA
Operating Temperature		-25 ~ 85	°C
Lead Soldering Temperature	T_{SOL}	260 (10 sec.)	°C

4.2. ELECTRICAL CHARACTERISTICS

PARAMETER	MIN	TYP	MAX	UNITS
Common Mode Impedance (at 100 MHz)	63	90	112.5	Ω
Cut-off Frequency		3		GHz
DC Resistance			6	Ω
Insulation Resistance	10			M Ω

4.3. TYPICAL CHARACTERISTICS

Impedance vs Frequency Characteristics*

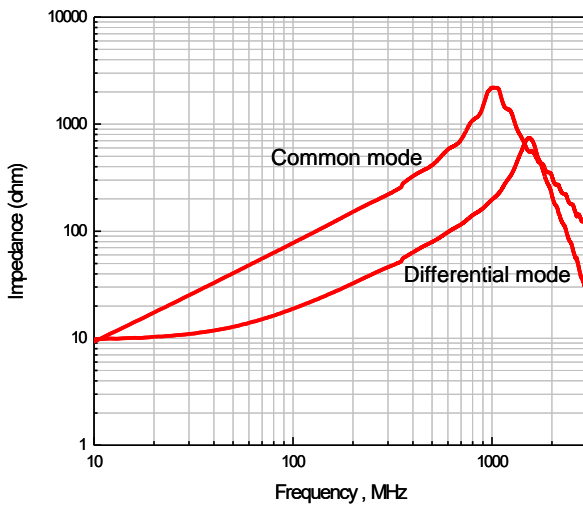

Insertion Loss vs Frequency Characteristics**

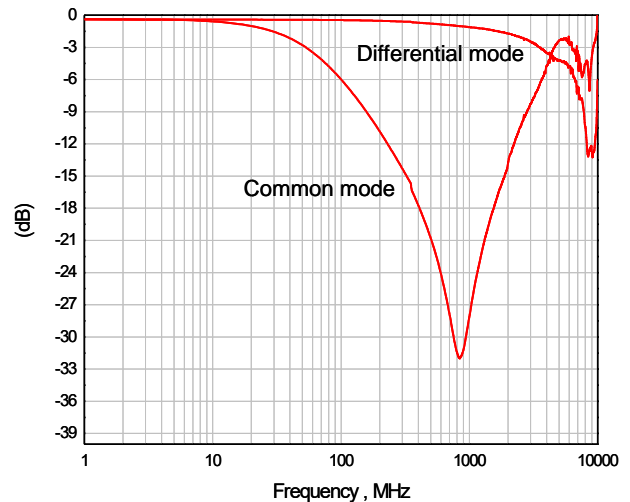

*Test Instrument: HP4291A Impedance/Material Analyzer

**Test Instrument: Agilent E5071C ENA-L Network Analyzer

4.4. MSL Level : Level 1

4.5. Storage Condition with package

Storage Time : 12 months

Storage Temperature : 5 to 40°C

Relative Humidity : < 65 %

5. LAND LAYOUT

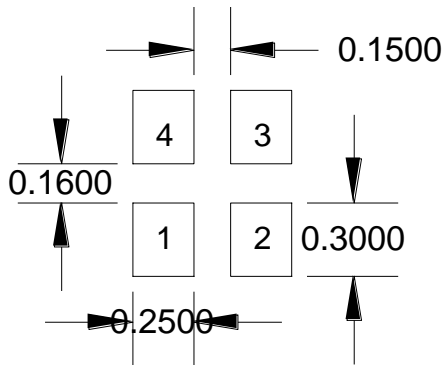

Dimensions in mm

6. Recommendable reflow soldering

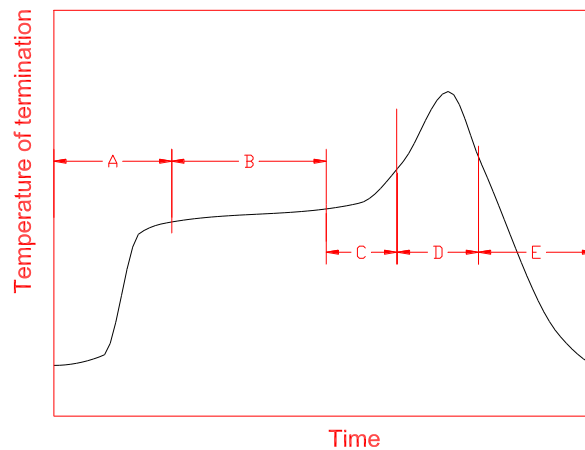

A	1 st rising temperature	The normal to Preheating temperature	30s to 60s
B	Preheating	140°C to 160°C	60s to 120s
C	2 nd rising temperature	Preheating to 200°C	20s to 40s
D	Main heating	if 220°C if 230°C if 240°C if 250°C if 260°C	50s~60s 40s~50s 30s~40s 20s~40s 20s~40s
E	Regular cooling	200°C to 100°C	1°C/s ~ 4°C/s

- According to J-STD-020C

7. Tape and reel specifications

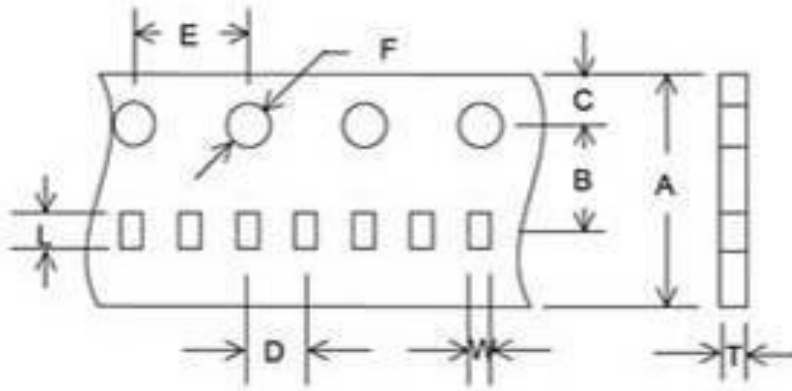

A	8.00±0.10
B	3.50±0.05
C	1.75±0.1
D	2.00±0.05
E	4.00±0.10
F	1.5±0.10
L	0.78±0.03
W	0.65±0.03
T	0.42±0.03
Unit : mm	

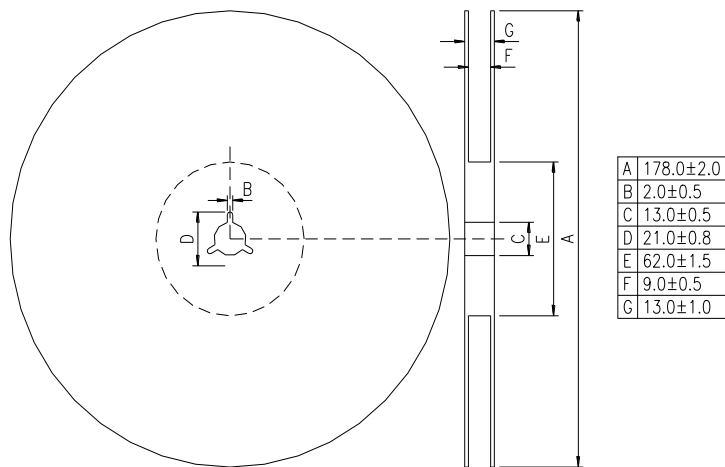

*Standard quantity : 10000 pcs/Reel